



国际空间科学研究所 - 北京

太空 | TAIKONG

ISSI-BJ Magazine

No. 9 October 2016

LINK BETWEEN
SOLAR WIND, MAGNETOSPHERE,
AND IONOSPHERE

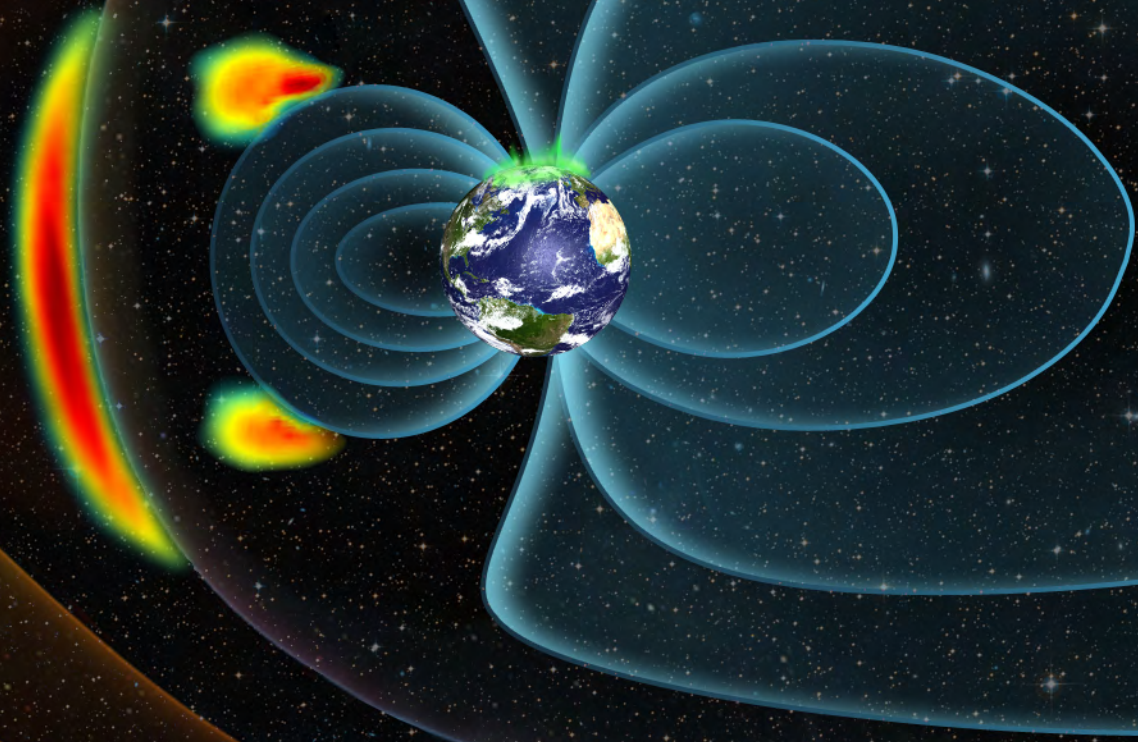
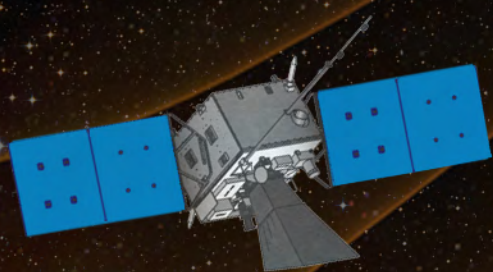

FOREWORD

IMPRINT

太空 | TAIKONG
ISSI-BJ Magazine



Address: No.1 Nanertiao,
Zhongguancun,
Haidian District,
Beijing, China
Postcode: 100190
Telephone:
+86-10-62582811
Website:
www.issibj.ac.cn

Authors

Graziella Branduardi -
Raymont (MSSL-UCL, UK),
C. Philippe Escoubet (ESA/
ESTEC, The Netherlands),
Kip Kuntz (JHU/APL, USA),
Tony Lui (JHU/APL, USA),
Andy Read (Leicester U.,
UK), David Sibeck (NASA/
GSFC, USA), Tianran Sun
(NSSC/CAS, China), Brian
Walsh (Boston U., USA),
Chi Wang (NSSC/CAS,
China)

Editors

Anna Yang
Maurizio Falanga

Front Cover

An artist's impression of the
Solar-wind Magnetosphere
Ionosphere Link Explorer
(SMILE) mission.

(Credit: CAS;
Special thanks to:
Chi Wang)

On July 6-7, 2016, the International Space Science Institute in Beijing (ISSI-BJ) successfully organized a two-day Forum on "The Link between Solar Wind, Magnetosphere, Ionosphere". ISSI-BJ Forums are informal, free debates, and brainstorming meetings among high-level participants on open questions of scientific nature. In total, 28 leading scientists from eight countries participated in this Forum, which was convened by Chi Wang (NSSC, CAS), Graziella Branduardi-Raymont (MSSL-UCL, UK), Benoit Lavraud (CNRS, France), Tony Lui (APL, USA), and Maurizio Falanga (ISSI-BJ, China).

The Forum's main aims divided the meeting into 4 sessions: Overview of the Solar Wind Magnetosphere and Ionosphere Coupling; Key Science of the Solar wind, Magnetosphere, Ionosphere Coupling; Instruments and Capability Required; Synergies Complementary Missions and International Collaborations. In this context, the European Space Agency (ESA) and the Chinese Academy of Sciences (CAS) selected a joint small mission (SMILE, to be launched in 2021) to trace these processes from beginning (the Sun) to end (the Earth's aurora), and investigate – in a way unmatched so far – how the solar wind interacts with the Earth's magnetic environment.

The Forum started with an overview and goals of the SMILE mission. The participants discussed the interaction between the Earth's protective shield – the magnetosphere – and the supersonic solar wind. SMILE is expected to give an important contribution to our understanding of space weather and, in particular, the physical processes taking place during the continuous interaction between the solar wind and the magnetosphere. The participants

recognized the very high scientific value of the mission, and raised constructive comments and suggestions on the mission concept, payloads key techniques, and data product. They concluded that the SMILE mission has complementary objectives to existing or future solar space plasma missions. Therefore, the SMILE mission is yet another excellent example of how the Chinese Space Science institutions can work together with the European Space Agency on innovative and challenging, and complementary to the existing, missions. This offers significant opportunities for cooperation through mission coordination and scientific analysis that places SMILE and China-Europe in a central position, due to its unique objectives and technology.

This TAIKONG magazine provides an overview of the scientific objectives and the overall design of the SMILE project, including spacecraft and instrumentation discussed during the Forum.

I wish to thank the conveners and organizers of the Forum, as well as the ISSI-BJ staff, Lijuan En, Anna Yang, and Xiaolong Dong, for actively and cheerfully supporting the organization of the Forum. In particular, I wish to thank the authors, who, with dedication, enthusiasm, and seriousness, conducted the whole Forum and the editing of this report. Let me also thank all those who participated actively in this stimulating Forum.

Prof. Dr. Maurizio Falanga

Beijing

October 2016

INTRODUCTION

Forum Overview

The interaction between the solar wind and Earth's magnetosphere, and the geospace dynamics that result, comprise a fundamental driver of space weather, the conditions on the Sun, in the solar wind, and in the magnetosphere, ionosphere and thermosphere, that can influence the performance and reliability of technological systems and endanger human life and health. Understanding how this vast system works requires knowledge of energy and mass transport, and of the coupling both between regions and between plasma and neutral populations.

The Forum concentrated on the main scientific drivers for the Solar-wind Magnetosphere Ionosphere Link Explorer (SMILE) mission, and how they define the mission specifications, reviewed lessons learned from the previous in situ and imaging missions, discussed the SMILE mission for soft X-ray magnetospheric imaging and UV auroral imaging, compared the soft X-ray simulated results from different numerical models, and examined opportunities for synergies with complementary observations from other space missions and ground-based facilities. The

Forum also reviewed the current status and future plans for SMILE, the primary scientific goals, the needed technologies, and how to best optimize international collaborations.

The forum was sponsored by ISSI-BJ, with partial support from the State Key Laboratory of Space Weather, National Space Science Center (NSSC), and the Chinese Academy of Sciences (CAS).

Background of the Solar Wind, Magnetosphere, Ionosphere

The solar wind is a stream of charged particles (protons, electrons, and heavier ionized atoms) released from the upper atmosphere of the Sun. The solar wind is divided into two components, respectively termed the slow solar wind and the fast solar wind. The slow solar wind has a velocity of about 400 km/s, a temperature of $1.4\text{--}1.6 \times 10^6$ K and a composition that is a close match to the solar corona. By contrast, the fast solar wind has a typical velocity of 750 km/s, a temperature of 8×10^5 K and it nearly matches the composition of the Sun's photosphere. Near the Earth, the solar wind encounters the Earth's magnetic field and the particles are deflected by the Lorentz force. The solar

wind compresses the sunward side of the magnetosphere but drags the nightside out into a long magnetotail.

The interaction of the solar wind with Earth leads to the formation of the magnetosphere, including the bow shock, magnetosheath, cusps, magnetopause and the magnetotail (Figure 1).

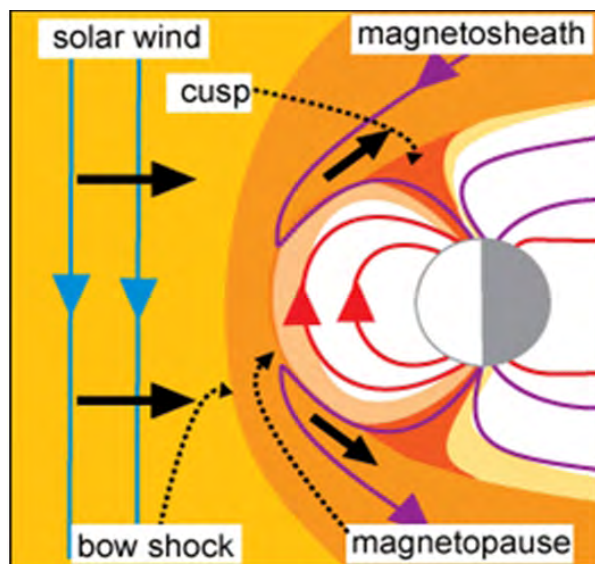

Fig. 1: The dayside magnetosphere. The magnetopause represents the outer boundary of the magnetosphere, and is compressed on the dayside. The bow shock compresses and deflects the solar wind so that it may flow around the magnetopause.

As shown in **Figure 1**, a collisionless bow shock stands upstream from the magnetopause in the supersonic solar wind. The shocked solar wind plasma flows around the magnetosphere through the magnetosheath. A relatively sharp transition from dense, shocked, highly ionized solar wind plasmas to tenuous, less highly ionized magnetospheric plasmas marks the magnetopause. High latitude cusps denote locations where field lines divide to close either in the opposite hemisphere or far down the magnetotail. Weak field strengths within the cusps provide an opportunity for solar

wind plasma to penetrate deep into the magnetosphere, all the way to the ionosphere. The ionosphere is a region of Earth's upper atmosphere, from about 60 km to 1,000 km altitude. It is ionized by solar radiation, plays an important part in atmospheric electrical activity and forms the inner edge of the magnetosphere.

The position and shape of the magnetopause change constantly as the Earth's magnetosphere responds to varying solar wind dynamic pressures and interplanetary magnetic field orientations. Both the fast

and slow solar wind can be interrupted by large, fast-moving bursts of plasma called interplanetary coronal mass ejections, or CMEs. When a CME impacts the Earth's magnetosphere, it temporarily deforms the Earth's magnetic field, changing its direction and strength, and inducing large electrical currents; this is called a geomagnetic storm and it is a global phenomenon. CME impacts can induce magnetic reconnection in the Earth's magnetotail; this launches protons and electrons downward toward the Earth's atmosphere, where they form the aurora.

GLOBAL MEASUREMENTS AND THE SOLAR WIND-MAGNETOSPHERE INTERACTION

Heliophysicists seek to understand, and model, the processes governing the flow of solar wind mass, energy, and momentum through the Sun - Solar Wind - Magnetosphere - Ionosphere system. With this knowledge in hand, they will be able to forecast geomagnetic storms, the most hazardous space weather events in the near-Earth environment. Storms enhance the fluxes of energetic particles within the magnetosphere to levels capable of harming spacecraft electronics, drive powerful currents into the ionosphere that cause surges in electrical power line transmission, enhance exospheric densities and therefore drag on low-latitude spacecraft, and modify ionospheric densities in ways that severely impact GPS navigation and satellite communication.

A host of mechanisms have been proposed to explain the nature of the solar wind-magnetosphere interaction, and in particular the entry into, storage within, and release from the magnetosphere of solar wind mass, energy, and momentum (**Figure 2**). Proposed magnetopause entry mechanisms include solar wind pressure variations battering the magnetosphere, the Kelvin-Helmholtz (wind-over-water) instability on the magnetopause, diffusion driven by wave-particle interactions, and magnetic reconnection. Proposed magnetotail release mechanisms include a host of plasma instabilities, e.g. ballooning or cross-tail current driven instabilities, and magnetic reconnection.

In contrast to all the other mechanisms, reconnection predicts

enhanced interactions during intervals of southward interplanetary magnetic field (IMF) orientation. Therefore statistical studies of remote observations demonstrating that ionospheric convection, the strength of field-aligned currents into and out of the ionosphere, the likelihood of geomagnetic substorms, and the magnitude of geomagnetic storms all increase for southward IMF orientations, point to reconnection as the dominant mode of solar wind-magnetosphere interaction. Reconnection may be the cause or consequence of various plasma instabilities proposed to occur within the near-Earth magnetotail.

Reconnection is a microphysical process with macrophysical consequences. The need to understand the microscale

physics underlying reconnection has led to the launch of multispacecraft missions like ISEE-1/2, Cluster, THEMIS, and MMS with ever decreasing interspacecraft separations. These missions have confirmed the presence of the accelerated plasma flows, magnetic field components normal to the magnetopause and magnetotail current sheet, streaming energetic particles, and boundary layers containing admixtures of the particle populations on both sides of reconnecting current sheets at the magnetopause and within the magnetotail, just as predicted by reconnection models.

While isolated single or closely-spaced multipoint in situ measurements can be used to identify reconnection events and study the microphysics of reconnection, they cannot be used to distinguish between models in which reconnection is predominantly patchy or global, transient or continuous, triggered by solar wind features or occurring in response to intrinsic current layer instabilities, component and occurring on the equatorial magnetopause or antiparallel and occurring on the high-latitude magnetopause. Nor can isolated measurements be used to determine the global state of the solar wind-magnetosphere interaction, as measured by the rate at which closed magnetic flux is opened or open flux closed. For all of these tasks, and many more, global observations are needed. It would, however, be a major undertaking to launch a flotilla of

microsatellites capable of making in situ measurements at all relevant locations.

In the absence of any plans for such a constellation, imagers can supply the global measurements needed to understand the nature of the solar wind-magnetosphere interaction. The boundaries seen in soft X-ray (and low energy neutral atom) images correspond to plasma density structures like the bow shock, magnetopause, and cusps. Thus soft X-ray imagers can be used to track the inward erosion of the dayside magnetopause during the growth phase of geomagnetic substorms and the outward motion of this boundary following substorm onsets. The location of the magnetopause provides information concerning

the amount of closed flux within the dayside magnetosphere, the rate of magnetopause erosion or recovery provides information concerning the steadiness of reconnection, while the location of the portion of the magnetopause that moves provides information concerning the component or antiparallel nature of reconnection.

Soft X-ray imagers can also be used to track the equatorward motion of the cusps during the substorm growth phase and their poleward motion following onset. Just as in the case of the magnetopause, cusp observations can be used to determine the amount of closed flux within the dayside magnetosphere, the rates of erosion and recovery, the steadiness of reconnection, and the equatorial or

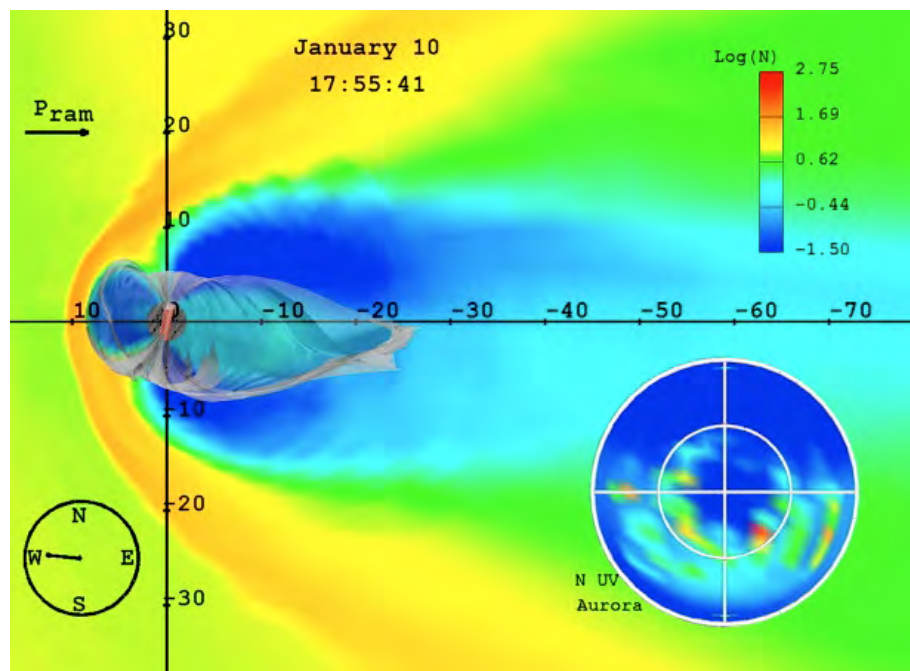

Fig. 2: A snapshot of the complex plasma density structures generated by the solar wind-magnetosphere interaction according to the Lyon-Fedder-Mobarry (LFM) global magnetohydrodynamic simulation (C. Goodrich, personal communication). Color shading indicates the density in the noon-midnight meridional plane, while lines in the lower density inner magnetospheric cavity suggest the magnetospheric magnetic field configuration. The inset in the lower right corner shows corresponding predictions for auroral activity in the northern hemisphere.

high-latitude location of reconnection.

Global auroral images from a high inclination, high altitude, spacecraft provide an excellent complement to soft X-ray images. The dimensions of the auroral oval indicate the open magnetic flux within the Earth's magnetotail. Poleward and equatorward motions of the dayside and nightside auroral oval provide crucial information concerning the occurrences and rates of reconnection at the dayside magnetopause and within the Earth's magnetotail. Ground-based auroral imagers frequently observe transients in the dayside aurora which can be interpreted as evidence for bursty reconnection and/or the Kelvin-Helmholtz

instability. Global imagers are needed to determine the occurrence rates and extents of these transients, which in turn determine their importance to the solar wind-magnetosphere interaction. Observations of the nightside auroral oval can be used to pinpoint the time of substorm onset, determine the extent of the reconnection line in the magnetotail, and distinguish between steady, bursty, and sawtooth modes of reconnection in the magnetotail. Global auroral images can be used to test the recently proposed hypotheses that plasma flows (and aurora) originating within the dayside oval and streaming across the polar cap trigger substorm onset when they reach the nightside oval.

Finally, measurements of the solar wind plasma and magnetic field input to the magnetosphere by a monitor located near Earth are essential for the above studies, because having such a monitor reduces concerns regarding the arrival times of possible solar wind triggers for magnetospheric events and reduces concerns regarding the dimensions of solar wind structures transverse to the Sun-Earth line. In situ measurements from the same plasma and magnetic field instruments on the observing spacecraft on an elliptical polar orbit can also play a crucial role in validating the inferences concerning processes at the magnetopause and in the magnetotail that are drawn from the soft X-ray and auroral imagers.

A NOVEL METHOD TO IMAGE THE MAGNETOSPHERE

Solar wind charge-exchange (SWCX) occurs when highly ionized species in the solar wind interact with neutral atoms. An electron from the neutral is transferred to the ion, initially in a highly excited state. On relaxation to the ground state one or more photons are emitted, usually in the extreme ultraviolet or the soft (low energy) X-ray. The energy band below 0.5 keV is extraordinarily rich in SWCX emission lines from a large number of ionization states of a large number of species, while the 0.5-2.0 keV band is dominated by a few strong lines due to charge-exchange by O^{+7} , O^{+8} , Ne^{+9} , and Mg^{+11} . There are many sources of SWCX emission in the heliosphere, including comets and the neutral interstellar medium that flows through the solar system. Typically the brightest source of

SWCX is that due to the Earth's exosphere, which is primarily hydrogen, interacting with the shocked, compressed, solar wind in the magnetosheath.

SWCX emission due to the magnetosheath was first observed by ROSAT, though its source was a mystery at the time. ROSAT scanned great circles through the ecliptic poles, with each scan overlapping ~95% of the previous scan. Comparison of successive scans revealed strong temporal variations with scales of hours to days that were dubbed the "Long Term Enhancements" (LTE). A large-scale minimization routine was used to isolate the LTE, though the absolute minimum level could not be determined. Comparison of the LTE rate during an observation of the Moon to the flux from the

dark side of the Moon suggested that the bulk of the emission was cis-lunar. The LTE rates were later shown to be strongly correlated with the solar wind flux, and thus likely to be due to SWCX.

The SWCX flux is given by the integral along the line of sight of $\zeta(n_n n_p v_{rel}) = \zeta Q$ where n_n is the density of neutral particles, n_p is the density of solar wind protons, v_{rel} is their relative velocities, and ζ contains the information about ion abundances, interaction cross-sections, branching ratios, etc. Q can be determined from MHD models of the magnetosheath. However the value of ζ for strong lines is sometimes quite uncertain, and for weak lines it is usually completely unknown. A recent comparison of the ROSAT LTE rates with the Q determined from

models for the solar wind during the ROSAT observations has led to a determination of ζ for the ROSAT $\frac{1}{4}$ keV band, which allows one to scale any MHD model of the magnetosheath to X-ray emissivity. Thus, one can feel relatively confident of the simulations of instrumental views of the magnetosheath.

Three different groups have been simulating the X-ray emission from the magnetosheath. Although there has as yet not been a detailed comparison, it is clear that useful parameters, such as the magnetopause distance, can be determined for a large range of observing aspects, so long as the spacecraft is sufficiently far from the Earth. Determining the magnetopause distance is particularly interesting, not only for the science goals described above, but also given the divergent

recent results from astrophysical missions.

SWCX emission from the magnetosheath has been observed by all recent astrophysical X-ray observatories. The XMM-Newton observatory is in high Earth orbit and sometimes observes through the nose of the magnetosheath. Given the expected SWCX X-ray brightness of the dayside magnetosheath such observations can serve as an important check on our simulations. Discrepancies when comparing predicted and observed emission strengths may be due to errors in the distances to the magnetopause predicted by the MHD models. The differences in the underlying MHD codes demonstrate the need for X-ray observations to constrain and validate the MHD results.

It should also be noted that studies of the X-ray emission from the magnetosheath require wide-field imagery, an area of current interest in astrophysics. For low to median solar wind conditions, the signal from the magnetosheath is only a few times stronger than the soft X-ray background. Thus, study of the X-ray emission from the magnetosheath will require astrophysical techniques and expertise. In return, astrophysics is deeply interested in detecting the Warm Hot Intergalactic Medium through O^{+6} and O^{+7} emission, and thus depends upon researches such as these to characterize and remove the SWCX emission. Understanding the SWCX from the magnetosheath will necessarily require interdisciplinary study.

AURORA AND SUBSTORM



Fig. 3: Northern aurorae viewed by the IMAGE spacecraft (FUV instrument) on 15 July 2000 (Credit: NASA). The aurorae follow an oval approximately centred on the Earth magnetic pole.

A visible manifestation of the solar wind-magnetosphere-ionosphere coupling system is the aurora (**Figure 3**). A well-recognized analogy of how aurora provides a vivid image of this coupling is that of a cathode-ray tube in the old-fashioned television set. The ionosphere acts like the screen of the television set and the aurora represents the image formed by electron beams generated within the system due to its electromagnetic coupling activities. With this analogy in mind, one could extract valuable insights on the state as well as sites of disturbances of this coupled system.

Although geomagnetic storms that last for days were

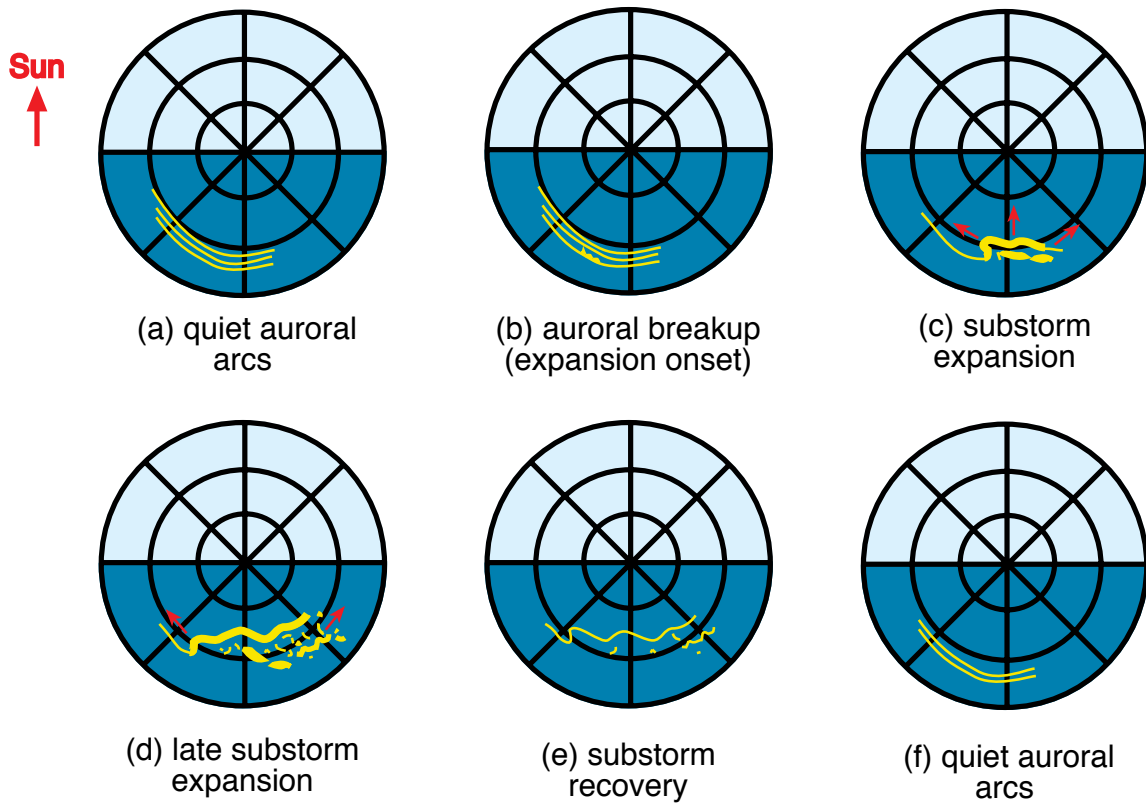

Fig. 4: A schematic diagram to illustrate the sequence of global auroral distribution viewed from above the North Pole during the progress of an auroral substorm. The concentric circles are the geomagnetic latitudes 10° apart.

recognized early in space research as major disturbances, a breakthrough came in the mid-1960s suggesting that geomagnetic storms seemed to be built up by a more fundamental disturbance period that lasts for only a few hours based on auroral observations from a network of All-Sky-Cameras (ASCs) in the polar region. Hence, that fundamental disturbance interval was named substorm. In particular, the substorm interval can be broken down into two phases initially, namely, expansion and recovery, as illustrated by the global auroral morphology depicted in **Figure 4** when viewed from above the North Pole. Prior to substorm expansion, auroras occur often as arcs aligned more or less parallel to the geomagnetic latitudes in a circumpolar belt known as

the auroral oval (**Figure 4a**). At substorm expansion onset, one of the parallel arcs, typically the most equatorward one, brightens (**Figure 4b**) and breaks up as the auroral activities expand poleward, westward as a surge-shape form, and eastward as auroral patches (**Figure 4c-4d**). After about half an hour of these activities, auroral activities stop advancing poleward, westward and eastward, followed by gradual retreat and diminishing of former auroral activities (**Figure 4e**) to return to the pre-substorm-expansion auroral distribution (**Figure 4f**). Later research indicated that this cyclical concept could be extended to describe disturbances in the magnetosphere as a whole and an additional phase, called the growth phase, was added to mark the

interval when magnetospheric energy is accumulated for later release for substorm activities. Furthermore, it was later found that the buildup of some geomagnetic storms could occur without having frequent substorm occurrence.

In spite of the discovery of the substorm concept more than half a century ago, the physical process for its development as well as the possible solar wind features linking to its occurrence are still open questions. There are some recent developments that may give us the possibility to resolve these open questions when coordinated global observations, such as SMILE will return, and ground-based auroral observations are combined to address these issues.

The first development is the recently proposed link based on ground-based observations. This link suggests that some solar wind features initiate ionospheric disturbances on the dayside auroral oval. These disturbances are visible as auroral patches and/or ionospheric enhanced flows in the polar region moving to the nightside away from the Sunward direction. When these features reach the nightside poleward boundary of the auroral oval, the aurora at that location brightens and sends equatorward another auroral feature, known as auroral streamer, presumably related to fast plasma flows in the magnetotail. When this auroral streamer reaches the equatorward portion of the auroral oval and touches a pre-existing auroral arc, it leads to the development of auroral substorm disturbances in association with magnetospheric disturbances such as plasma injections into the inner magnetosphere to form the ring current that is responsible for the world-wide depression of equatorial geomagnetic field at the Earth.

The check on the validity of this sequence of events can be improved drastically from what can be done presently by incorporating a global view of auroral observations from both the dayside and nightside. The global auroral imaging from a satellite such as SMILE would allow activities from these different local times to be monitored simultaneously. Present networks of ASCs do not cover aurorae globally and even when pieced together from individual ASCs images, the global view suffers distortion of aurorae due to the fish-eye lens used in ASC

and disjoint features appear when joining images from different ASCs. Most importantly, with simultaneous monitoring of the solar wind impacting the dayside magnetosphere, the solar wind features that cause the initiation of the dayside activity that eventually leads to a substorm development can be identified with ease. This would be a tremendous advance over the prevailing perception that southward IMF is generally favorable for substorm development without the more refined identification of any specific solar wind feature.

A second recent development is the awareness of a low-intensity auroral feature called auroral beads that develop in pre-breakup auroral arcs that eventually produce the initial brightening and substorm

expansion onset. This feature was not recognized earlier due to its low intensity and is shown in **Figure 4b**. The auroral beads have specific wavelengths and corresponding exponential growth in the auroral intensity that are different from case to case, apparently dependent on the state of the magnetosphere just prior to substorm expansion onset. The characteristics of auroral beads revealed recently impose another set of rather severe observational constraints that discriminate among several potential substorm onset processes under consideration. Two potential plasma instabilities that may account for these characteristics are the ballooning instability and the cross-field current instability. The latter was recently examined and was found to account for the observed auroral

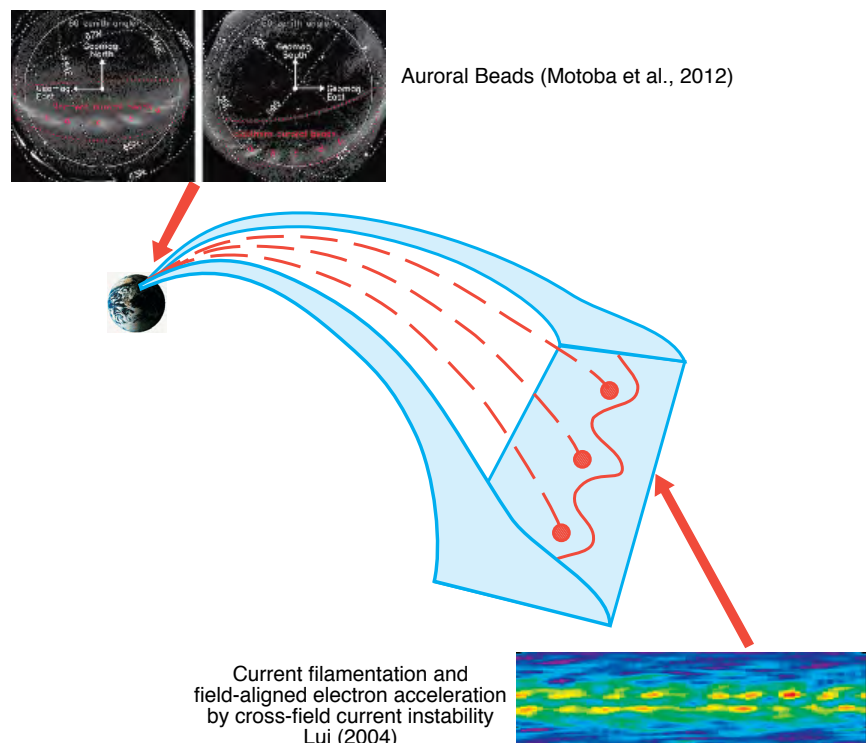

Fig. 5: A schematic diagram to show (top) the conjugacy of auroral beads by ground-based observations from both Northern and Southern hemispheres, (middle) the wavelengths in the magnetospheric equatorial plane corresponding to auroral beads, and (bottom) the current filamentation and electron acceleration arising from the excitation of the cross-field current instability.

bead characteristics, as illustrated in **Figure 5**. The coordinated global and ground-based auroral observations around substorm expansion onset would be ideal to test these proposed plasma instabilities further.

Finally, another outstanding question that can be addressed by the SMILE mission

is whether or not interplanetary shocks impacting the magnetosphere can cause a substorm expansion. Traditionally, it was generally assumed that shocks could produce substorm expansion. However, a more dedicated investigation on this causality based on global auroral observations from NASA's Polar satellite indicated that interplanetary shocks in general

cause the magnetosphere to be compressed but often do not cause the sequence of auroral disturbances as schematically illustrated in **Figure 4**. The simultaneous observations of the solar wind and the global auroral morphology by the SMILE mission would allow ample opportunities to address this outstanding issue.

CUSP DYNAMICS

Since the first spacecraft observations identifying it nearly 40 years ago, the cusp has been widely recognized as the region with the most direct entry of the solar wind into the Earth's magnetosphere. Spatially, the cusps in the northern and southern hemisphere are broad at high altitude, spanning several Earth radii near the magnetopause, and funnel down to just 10s of km in the ionosphere. Passage of solar wind plasma along field lines down the throat of the cusp, to regions close to the Earth, means there is solar wind plasma penetrating deep into the Earth's neutral atmosphere. A high neutral density in the low altitude atmosphere combined with the solar wind plasma

means there are ample ingredients for charge exchange between heavy solar wind ions and neutrals in this region. The result is the emission of soft X-rays from the cusps.

Patterns of when, where, and how much solar wind enters the cusp also give valuable information regarding how solar wind plasma and energy are entering the Earth's magnetosphere and ionosphere. The converging magnetic topology of the cusp means the region collects information about processes occurring all along the dayside magnetopause. One particular feature that provides useful information is time-energy dispersions. **Figure 6**

provides a schematic diagram giving an example of this process. As magnetic field lines in the solar wind (blue in figure) reconnect with field lines in the magnetosphere (orange in figure), plasma flows into the magnetosphere. Depending on where reconnection occurs, the time-history effect will cause different density structures that can be imaged in soft X-rays.

For years researchers have used the ion structures to discern between different models of magnetopause reconnection. The structures or dispersions can provide information regarding when and where reconnection is initiated (poleward or equatorward of the cusp) as well as

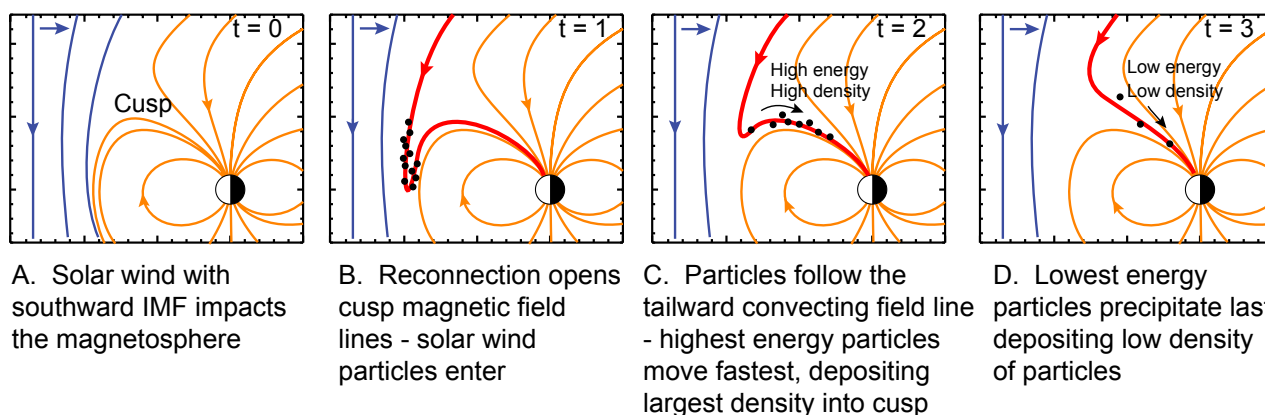

Fig. 6: Diagram of solar wind-magnetosphere coupling and the generation of energy and density structures in the cusps.

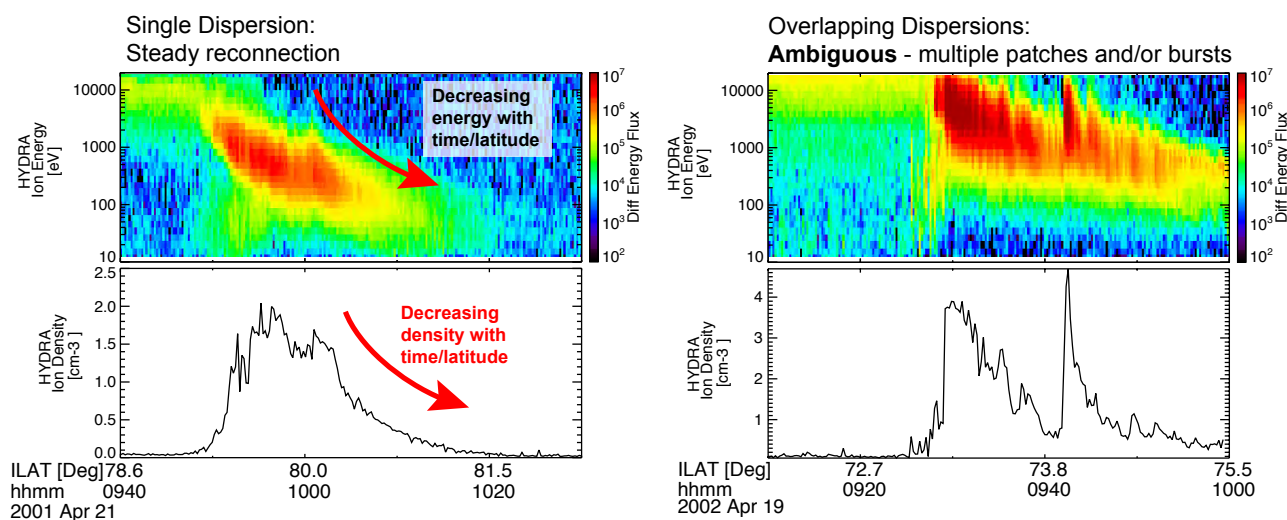

Fig. 7: Spacecraft measurements of a single cusp ion dispersion (**left**) and overlapping ion dispersions (**right**). The x-axis is time. The panels from top to bottom are ion energy spectra and ion density from the HYDRA instrument on NASA's Polar mission.

the time variability. Although in situ spacecraft measurements of ion dispersions can give information regarding the behavior of reconnection, point measurements have an inherent space-time ambiguity. **Figure 7** shows two examples of ion dispersions measured from NASA's Polar spacecraft passing through the cusp on two different days illustrating this challenge.

On the left is a single ion dispersion with decreasing density and particle energy as the spacecraft passes to higher

latitude in the cusp. This provides the classical picture of continuous reconnection equatorward of the cusp. On the right side of the figure is an example of overlapping ion dispersions. This may be providing evidence for a reconnection process that is occurring in many discontinuous patches. Or, the observations may be evidence for a single extended reconnection line turning on and off. With point measurements from single spacecraft in the cusp we are unable to separate these models.

X-ray imaging of the cusp provides the potential to monitor the entire ion dispersion as a function of time. With knowledge of the entire temporal and spatial history of cusp ion dispersions from upcoming wide field-of-view (FOV) soft X-ray missions such as the Cusp Plasma Imaging Detector (CuPID) Cubesat Observatory as well as SMILE, the community may be able to separate the causes of these observational signatures and develop a deeper understanding into how reconnection is occurring at the dayside magnetopause.

MODELING SOLAR WIND-MAGNETOSPHERE INTERACTION AND FIELD OF VIEW

The solar wind-magnetosphere interaction can be modeled by global MHD codes, for example, the 3-D PPMLR (extended Lagrangian version of the piecewise parabolic method) MHD code jointly developed by the University of Science and Technology of China (USTC) and the National Space Science

Center (NSSC), CAS. It solves the ideal MHD equations in the numerical domain extending from 30 to $-300 R_E$ along the x axis and from -150 to $150 R_E$ in y and z directions of the geocentric solar magnetospheric (GSM) coordinate frame. The minimum grid spacing for the present simulation is $0.4 R_E$.

The Earth's dipole tilt is set to be zero and the ionosphere is simplified as a spherical shell with a uniform Pedersen conductance and a zero Hall conductance.

The X-ray intensity for a particular line of sight can be estimated by the line integration

of volume emission rate (P) [Cravens, 2000]:

$$I = \frac{1}{4\pi} \int P dr = \frac{1}{4\pi} \int \alpha n_H n_{sw} \langle g \rangle dr$$

(keV cm⁻² s⁻¹ sr⁻¹)

where α is the efficiency factor, which is taken to be 1×10^{-15} eV cm² in our simulations, n_H is the number density of the exospheric hydrogen and n_{sw} that of the solar wind. Integration of P over the line of sight starts from the satellite position to $r = 80 R_E$. X-ray emission beyond $80 R_E$ is neglected as the density of exospheric hydrogen drops dramatically there.

We use a solar storm on Sept. 12, 2014, with an ICME reaching the Earth at ~15:20 UT, to simulate the response of the Earth's magnetosphere and its environment to the incoming solar wind. The simulated X-ray intensity for the storm event is shown in the left column of **Figure 8**. From the top to the bottom, the panels show the X-ray intensity from the dayside magnetosheath and cusps before (top row) and after (second row from the top) the arrival of the interplanetary shock, as well as the response of the magnetosphere to the interplanetary magnetic field turning from northward (third row) to southward (fourth row). Furthermore, the above modeled X-ray intensity is converted into observed X-ray counts by using an X-ray telescope simulator. The simulator assumes an optic which uses square-channel micropore plates in a Lobster eye configuration. The detector is assumed to have the quantum efficiency (QE) characteristics of a back-illuminated charge-coupled device (CCD) and has an

optical/UV filter as required by astrophysical X-ray telescopes. The combined QE of detector and filter is essentially identical to the EPIC-PN instrument with the medium filter on XMM-Newton. The exposure time is 300 s for the simulations shown here.

After the shock arrival (2nd row from the top of **Figure 8**) a substantial increase of X-ray emission is observed as well as a compression of the magnetosphere due to increase of pressure at the magnetopause. After the turning of the IMF from northward to southward (4th row on **Figure 8**) the magnetopause is also observed to move inward, most likely due to the erosion of the dayside magnetosphere by magnetic reconnection.

The FOV of the X-ray instrument is changing as the spacecraft moves along its orbit. A sophisticated simulator with specified orbit, visibility and FOV (**Figure 9**) was developed for all general Earth/orbit/magnetosheath/cusps etc. configurations (see the SMILE Website <http://www.star.le.ac.uk/amr30/SMILE/> for examples of the simulator outputs). It is a very useful visualization tool, able to create movies of what can be observed from a particular orbit, and also able to calculate observability efficiencies, i.e. what percentage of the considered orbit and configuration a certain target (nose, cusp etc.) is visible or not due to the various constraints (e.g. bright Sun, bright or obscuring Earth, baffle considerations, radiation flux, etc.). Relevant environmental parameters that go into the simulator are the position

and size of the cusps, and the position, shape and size of the magnetopause – here assumed to be a Shue-model (Shue et al. 1997) shape with $\alpha=0.6$, with the nose of the magnetopause at [10.0, 0.0, 0.0]. Initially assumed to have a fixed position with an Earth radius size, the cusps have recently been modeled using a more realistic shape that uses three magnetic field lines at 10, 12 and 14 H MLT that change position with the dipole tilt and the season (from the Tsyganenko 1996 model). The SMILE design parameters that are relevant are the FOV and orientation of both the SXI (16° x 27°, short-side along the Earth-Sun line) and the UVI (10° x 10°), the offset between these (22.8°), and the SXI Earth avoidance angle (10°). The simulator takes a spacecraft orbit and these parameters and predicts what can be observed during the orbit. It is used to explore a number of high-ellipticity, high-inclination orbits in order to determine the optimal choice.

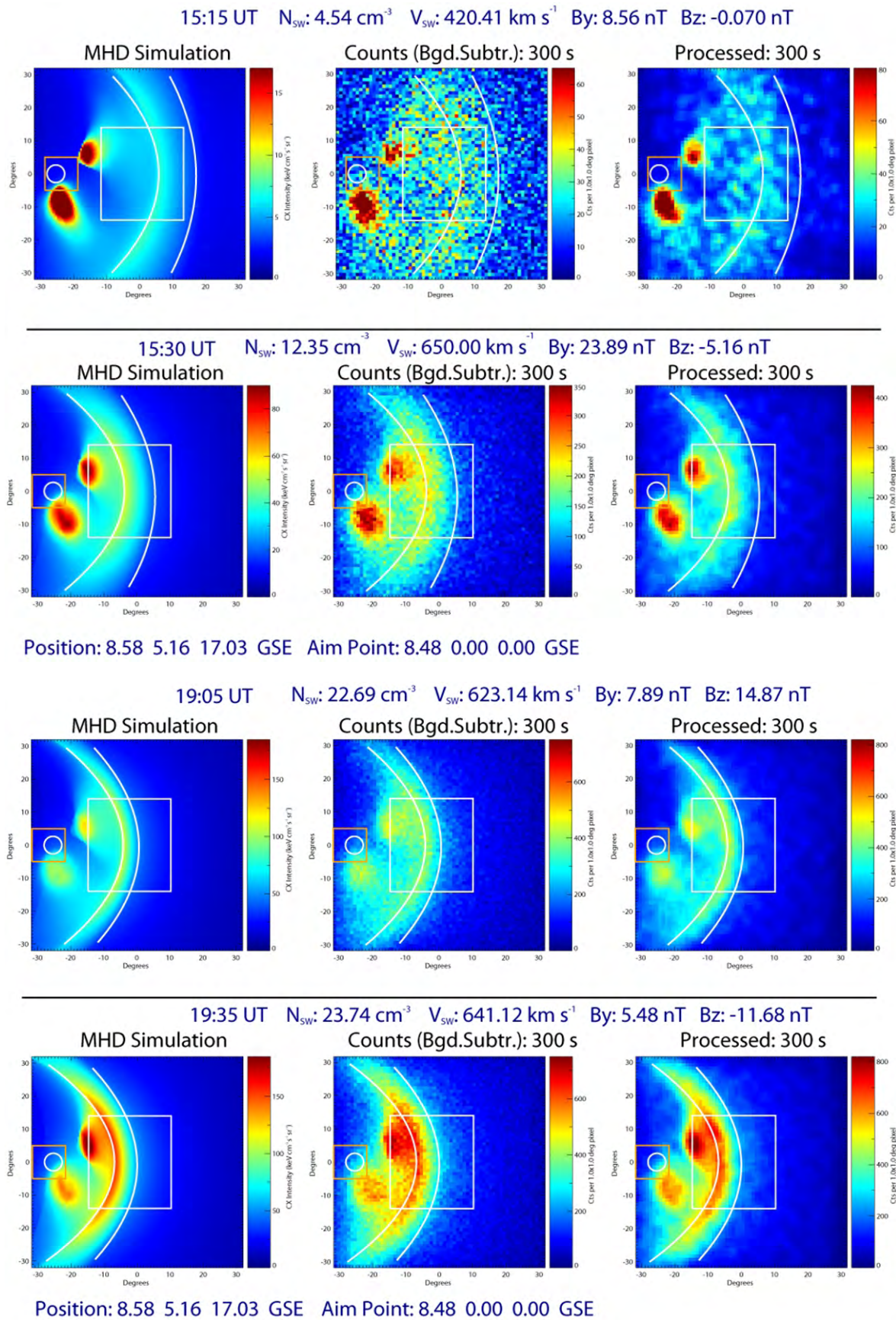

Fig. 8: Simulated dayside magnetosphere before (**first row**) and after (**second row**) the arrival of an interplanetary shock, as well as its response to the interplanetary magnetic field turning from northward (**third row**) to southward (**fourth row**). The figure shows original MHD simulation data (**left**), the predicted soft X-ray counts (**center**) and the processed image (**right**).

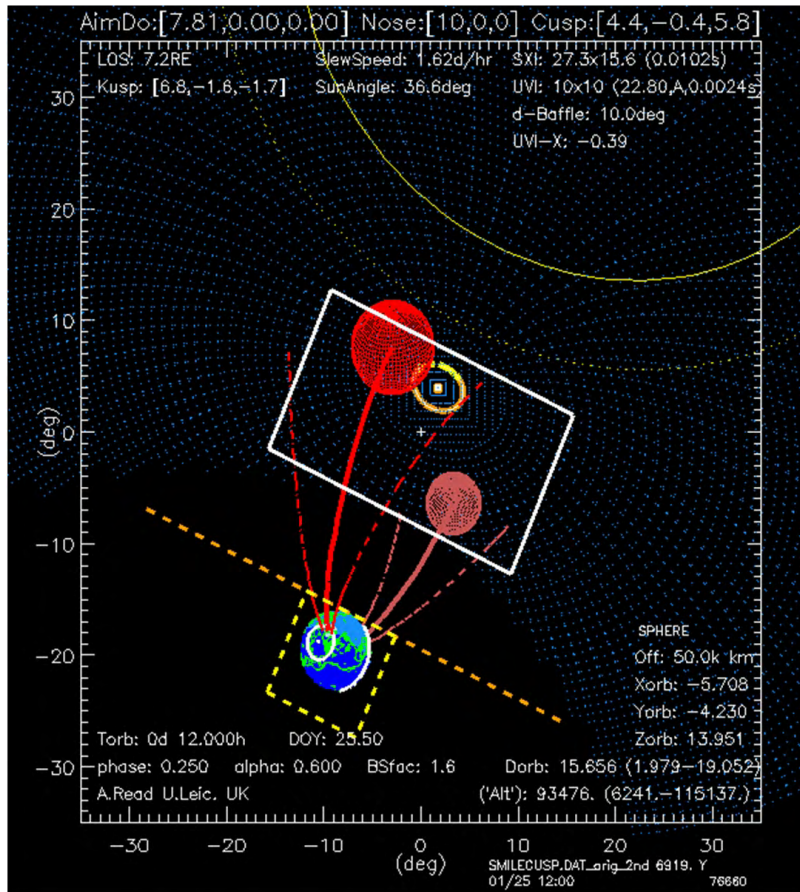

Fig. 9: SXI instrument FOV (white rectangle) and UVI instrument FOV (yellow square). The nose of the magnetosphere is shown with a yellow oval at (10.0, 0.0, 0.0) R_E and the cusps are shown by the red (North hemisphere) and pink (South hemisphere) spheres and by the red and pink magnetic field lines. The SXI Earth avoidance baffle angle is shown with the orange dashed line. The sun avoidance angle is shown by the large yellow unbroken curve.

SMILE SCIENTIFIC OBJECTIVES AND MISSION OVERVIEW

The Solar wind Magnetosphere Ionosphere Link Explorer (SMILE) is a novel self-standing mission to be jointly developed between the European Space Agency (ESA) and the Chinese Academy of Sciences (CAS). A joint call for new missions was published in January 2015 by ESA and CAS. The SMILE mission was then proposed by an international team of scientists, led by a Chinese and a European Principal Investigator, in March 2015. Following a technical and scientific review, the SMILE mission was selected

in November 2015. The launch is planned for the end of 2021.

Understanding and thus predicting the non-linear global system behaviour of the magnetosphere has remained both the central objective and grand challenge of solar-terrestrial physics in particular (and space plasma physics more generally) for more than 50 years.

In situ data have dramatically improved our understanding of the localised physical processes involved (reconnection,

diffusion, boundary instabilities, turbulence, particle acceleration, etc.). Multi-point and multi-scale missions such as Cluster, THEMIS and, more recently, MMS proceed down this path with an ever-increasing focus on the microscopic physics of space plasmas. However, piecing the individual parts together to make a coherent overall picture, capable of explaining and predicting the dynamics of the magnetosphere at the system level has proved to be extremely difficult. This is due to the fact that it is fundamentally

impossible to determine the global behaviour of a complex system with sparse in situ measurements, even with the support of increasingly sophisticated global computer models of the solar wind – magnetosphere interaction.

To address this global aspect, SMILE will explore the solar wind-magnetosphere coupling via X-ray images of the magnetosheath and polar cusps, UV

images of global auroral distributions and simultaneous in situ solar wind/magnetosheath plasma and magnetic field measurements. Remote sensing of dayside magnetosheath and the cusps with X-ray imaging is now possible thanks to the relatively recent discovery of solar wind charge exchange (SWCX) X-ray emission, first observed at comets, and subsequently found to occur in the vicinity of the Earth's magnetosphere.

SMILE will answer the following science questions:

- What are the fundamental modes of the dayside solar wind/magnetosphere interaction?
- What defines the substorm cycle?
- How do CME-driven storms arise and what is their relationship to substorms?

What are the Fundamental Modes of the Dayside Solar Wind/Magnetosphere Interaction?

Dayside reconnection causes plasma to flow anti-sunward through the magnetopause boundaries, the cusps, and over the polar caps. On occasions reconnection can persist for long times, both for northward and southward interplanetary magnetic field (IMF) orientations (e.g. Frey et al. 2003; Phan et al. 2004). However, reconnection can also be bursty and time dependent, generating significant structure. For example, patchy reconnection (Russell and Elphic 1978), bursty (i.e., time dependent) reconnection from a single X-line (Scholer 1988; Southwood et al. 1988), and multiple X-line reconnection (Lee and Fu 1985; Raeder 2006; Omididi and Sibeck 2007), may produce so-called flux transfer events (FTEs) which, at the most basic level, may be thought of as time dependent structures propagating along the magnetopause.

It is thought that steady reconnection occurs for low beta (i.e. magnetic field pressure dominated) solar wind and magnetosheath, whereas unsteady

reconnection is more likely for high beta solar wind conditions. However, a simple confirmation of this hypothesis is obscured by the fact that apparently unsteady magnetopause reconnection may simply be directly driven by variations in the solar wind parameters.

The peculiar magnetic topology of the cusps means that they also play a pivotal role in magnetospheric dynamics: they are the sole locations where solar wind has direct access to low altitudes (e.g. Cargill et al. 2005). They are essentially the boundary that separates magnetic field lines that close in the dayside hemisphere from those that extend far down the magnetotail. During subsolar reconnection solar wind energy, mass and momentum are transferred through the cusp into the magnetosphere. As described above, this momentum transfer is the major driver of large-scale magnetospheric convection, reflecting again the pivotal role of these regions. Since the cusps are the endpoints of a large portion of the

magnetospheric magnetic field, their structure gives information about a larger context than any other structure within the magnetosphere.

The latitudinal location of the cusp depends on the level of interconnection of the Earth's dipole with the IMF (Newell et al., 1989), i.e. the amount of recently 'opened' magnetospheric magnetic flux. When the solar wind magnetic field points southwards, magnetic reconnection at the magnetopause opens closed dayside magnetic field lines, causing the region of open field lines in the polar cap to expand to lower latitudes. The latitudinal position of the cusp is also an indicator of the Region 1 current and how much magnetic flux is being removed from the dayside to fuel substorm behaviour on the nightside. When the IMF turns northward, the cusps move poleward. This might be because reconnection at the dayside magnetopause stops, while reconnection within the magnetotail continues to close magnetic field lines which then

convect to the dayside magnetosphere (e.g. Milan et al. 2003).

However, it might also occur because reconnection poleward of both cusps appends magnetosheath magnetic field lines to the dayside magnetosphere, transforming open lobe magnetic field lines into closed dayside magnetic field lines and allowing the immediate entry of dense magnetosheath particle fluxes into the magnetosphere (Song and Russell 1992). The cusps, being by definition the boundary between open lobe and closed dayside field lines, should move to lower and higher latitudes as the open field line region expands and contracts, respectively. The amount of open flux depends on the rate of reconnection both on the dayside magnetopause and in the nightside magnetotail plasma sheet. It is thus of key importance to measure how the cusp responds to northward and southward turnings of the IMF, since this is intimately related to the strength of the solar wind – magnetosphere coupling.

The cusp latitude is directly related to the level of open flux within the magnetosphere, which in turn is controlled by the main mechanism of energy transfer, the reconnection process. Although crucial in understanding the system energetics quantitatively, the amount of energy transfer is difficult to

assess with in situ measurements because it occurs over a large area of the magnetopause. Therefore this critical parameter determining the magnitude of dynamical events accurately has only been assessed with correlative studies.

Further complexity is introduced by the east-west (or dawn-dusk) component of the IMF. The northern cusp moves duskward and the southern cusp dawnward during periods of duskward IMF orientation, and in the opposite directions during intervals of dawnward IMF orientation (e.g. Newell et al. 1989; Taguchi et al. 2009a). We understand these changes in terms of magnetic reconnection: when the IMF points duskward, antiparallel reconnection is expected in the post-noon northern hemisphere and pre-noon southern hemisphere. Plasma enters the magnetosphere from the cusp along the newly reconnected magnetic field lines, which then move anti-sunward in response to pressure gradient forces, but often initially move towards local noon under the influence of curvature forces (e.g. Smith and Lockwood 1996).

Finally, the solar wind dynamic pressure may play a role in determining cusp latitude. LEO observations from e.g. DMSP and simulations predict that enhanced (reduced) pressures may cause the cusp to

move equatorward (poleward) (e.g. Newell and Meng, 1994; Yamauchi et al. 1996; Palmroth et al. 2001).

Reconnection is therefore thought to cause the shape of the magnetopause to become blunter. By contrast, variations in the solar wind dynamic pressure should cause self-similar changes in magnetospheric dimensions. Thus by measuring: the curvature, size and absolute location of the magnetopause; and the location (latitudinal position), size, and shape of the cusps, it is possible to distinguish the differing effects of pressure changes and magnetic reconnection on the global magnetospheric system. This would distinguish on a global level the nature of the solar wind magnetosphere interaction, the dominant driving mechanisms and modes of interaction.

The measurements required to address the first science objective are as follow:

- steady/unsteady solar wind variations
- steady/unsteady motion of the dayside magnetopause
- transient brightenings and equatorward leaps in the dayside auroral oval
- transient brightenings and equatorward leaps in the cusp

What Defines the Substorm Cycle?

We know that southward IMF is required to increase the energy density of the magnetotail lobes, and the more prolonged

the interval of southward IMF, the more energy is stored, but the precise nature of the energy loading and the role it

plays in the subsequent onset of geomagnetic activity is very controversial. For example one very fundamental question is

whether each substorm requires its own interval of loading (growth phase), or whether multiple substorms can occur in response to a single growth phase.

The polar cap is an area of magnetic field lines that are open to the solar wind and is readily identified by the auroral oval which bounds it. Auroral oval observations provide information about the ionospheric footpoints of magnetopause processes. Specifically, the expanding-contracting polar cap paradigm utilises basic properties of the auroral oval to provide direct measurements of the state of the magnetosphere by measuring the size of the polar cap (e.g. Milan et al. 2012). The area of open flux within the polar cap changes directly in response to the amount of open flux in the magnetotail lobes, and the very dynamic changes that occur in this region are in response to different solar wind conditions.

The trigger that leads to substorm onset remains controversial. Is the substorm triggered by changes in IMF orientation (related to a change in shape of the magnetopause due to reconfiguration of magnetospheric currents associated with dayside reconnection) (e.g. Hsu and McPherron 2002; Lyons et al. 1997; Morley and Freeman 2007; Wild et al. 2009)? Or do solar wind dynamic pressure changes play the key role (by compressing the magnetotail) (e.g. Boudouridis et al. 2003;

Hubert et al. 2006, 2009; Milan et al. 2004)? How large and rapid must these driving changes be? Another viewpoint is that the external solar wind condition provides only the general configuration of the magnetosphere for substorm expansion onset. When and where it occurs depends on the ionospheric conditions as well as internal local magnetospheric parameters. Furthermore the role of the prior history of the magnetosphere in conditioning the response is not well understood and there are reports of substorms with no obvious external drivers (Huang 2002).

Thus despite a plethora of in situ observations, fundamental questions remain unanswered. If the onset of a substorm is due to external driving, what is the nature of the driving mechanism, and how does this depend on the precise configuration of the magnetosphere?

Although the substorm is perhaps the most well-known type of magnetospheric event, other modes of magnetospheric behaviour are observed. During steady magnetospheric convection, anti-sunward ionospheric convection is observed, and so flux is being transferred from the dayside to the nightside, but the size of the polar cap does not change. Thus it is thought that reconnection at the day and night side is balanced. The solar wind drivers that enable steady magnetospheric convection are not well understood, because they can

persist for more prolonged intervals where in situ satellite data are not available. During saw-tooth events, which are oscillations of energetic particle fluxes at geosynchronous orbit recurring with a period of about 2–4 h (e.g. Henderson et al., 2006), the auroral oval expands and contracts with a period of a few hours. It is not clear if this is due to an intrinsic instability/mode of dynamic behaviour or if it corresponds to a series of repeating substorms. These may simply reflect the same internal physics being driven differently by the solar wind, or they may represent fundamentally different types of behaviour.

Disentangling these different modes of behaviour follows on from the first question. Once a substorm is triggered, what controls its subsequent evolution? To what extent is it sensitive to changes in the solar wind conditions, and how does this sensitivity depend on the internal state of the magnetosphere (e.g. substorm phase, amount of remaining stored energy, etc.)?

The measurements required to address the second science objective are as follow:

- location and motion of the dayside magnetopause boundary
- location and motion of the auroral oval
- substorm brightenings of the auroral oval
- solar wind input

How do CME-driven Storms Arise and What is Their Relationship to Substorms?

While intervals of southward IMF occur naturally in the solar wind, and so substorms occur on a daily basis (Borovsky et al. 1993), strong driving causing geomagnetic storms tends to occur in response to coherent solar wind structures, particularly Coronal Mass Ejections (CMEs) (Gonzales et al. 1999).

The degree to which solar wind plasma, momentum and energy enter the magnetosphere is characterized by so-called solar wind coupling functions (Gonzales 1990; Finch and Lockwood 2007). Physically, magnetic reconnection at the dayside magnetopause is enhanced if there is a strong interplanetary magnetic field component opposite to the dayside magnetospheric magnetic field, supplemented by fast solar wind, for an extended period of time.

CMEs are transient eruptions of material from the Sun's corona into space (Forbes 2000). CMEs propagate at super-magnetosonic speeds relative to the ambient solar wind, and play a particularly important role in the dynamics of the Earth's magnetic field because they can contain long intervals of southward IMF (e.g. Gonzales et al. 1999). In general, the largest geomagnetic disturbances are associated with CMEs, with the level of activity being directly related to the flow speed, the field strength and the southward component of the magnetic field (Richardson et al. 2001).

Sometimes CMEs don't have the expected effects associated with a geomagnetic storm. When the interplanetary magnetic field is northward the energy transmitted to the magnetosphere is more limited. However, when solar filaments are contained in CMEs, there can be some effects similar to superstorms such as the super-fountain in the equatorial ionosphere, magnetotail stretching and strong joule heating in the polar ionosphere (Kozyra et al., 2014). Furthermore, Turc et al. (2014) showed that the Earth's bow shock can, under certain conditions, modify the interplanetary magnetic field direction contained in CMEs which then do not have the predicted effect on the magnetosphere.

Understanding the global CME/magnetosphere interaction is crucial to understanding precisely how the structure of the CME is responsible for the different phases of geomagnetic storms. On a practical level, storms driven by CMEs have potentially severe space weather consequences and represent a significant threat to infrastructure resilience worldwide.

Very basic questions still remain. Is the duration and magnitude of solar wind driving the sole arbiter of whether a storm will occur? What is the relationship between the storm and substorm? Are storms always a separate phenomenon, or can they be considered as being composed of multiple substorms?

Finally although the question of how a storm starts has been central to the scientific studies of the magnetosphere for as long as measurements have been available, the question of duration is growing in importance, driven by the needs of the end-user in the space weather context (i.e. confidence in issuing 'all clear'). Does a storm end because it has exhausted the reservoir of stored magnetic energy in the magnetotail? Or does a storm stop because the solar wind driving conditions have changed? If both possibilities are observed to occur, which is the more important? And once the solar wind driving is removed, how rapidly does the magnetosphere recover? Is it more likely that the solar wind conditions will change, or is the stored magnetotail lobe energy depleted so rapidly that the changing solar wind plays only a minor role?

The measurements required to address the third science objective are the same as the ones for the second science objective but should be done during a CME-driven storm:

- location and motion of the dayside magnetopause boundary
- location and motion of the auroral oval
- substorm brightenings of the auroral oval
- solar wind input

SMILE Mission Concept and Payload Design

As described above, SMILE will investigate the dynamic response of the Earth's magnetosphere to the impact of the solar wind in a unique and global manner, never attempted before. From a highly elliptical Earth polar orbit, SMILE will combine soft X-ray imaging of the Earth's magnetic boundaries and polar cusps with simultaneous UV imaging of the Northern aurora, while self-sufficiently measuring solar wind/magnetosheath plasma and magnetic field conditions in situ.

For the first time we will be able to trace and link the processes of solar wind injection in the magnetosphere with those acting on the charged particles precipitating into the cusps and eventually creating the aurora. SMILE will shed light on the fundamental drivers of this complex interaction, on how it takes place on a global scale, and how it evolves, which is still not understood. The science delivered by SMILE will have profound impact on our understanding of the way the solar wind interacts with the Earth's environment, and will pave the way to future space weather monitoring and forecasting satellites for which SMILE is an important scientific precursor.

In order to achieve the scientific objectives set out above the SMILE payload comprises: the Soft X-ray Imager (SXI), which will map spectrally the Earth's magnetic boundaries, magnetosheath and polar cusps; the UltraViolet Imager (UVI), dedicated to imaging the auroral regions; the Light Ion Analyser

(LIA) and the MAGnetometer (MAG), which will establish the solar wind/magnetosheath properties simultaneously with the imaging instruments.

The SXI is a wide FOV Lobster-eye telescope employing light weight (< 1 kg) micropore optic (MPO) to achieve soft X-ray imaging with large spatial coverage ($16^\circ \times 27^\circ$ FOV). At the telescope focus are charge coupled devices (CCDs) providing the good energy resolution required to map the SWCX X-ray emission and characterise the solar wind ionic population generating it. The CCDs need to be cooled to $\sim -70^\circ\text{C}$ in order to operate properly in the X-ray regime, and this is achieved by the use of a passive radiator. The SXI instrument development is led by the University of Leicester, UK (PI: Steve Sembay). Simulations of the modeled X-ray emissivity,



Fig. 10: CAD drawing of the SMILE SXI as viewed from the top. Clearly visible are the micropore optic arrays, protected from stray light by the baffle. X-rays are focussed onto CCDs located at the bottom of the (black) optical bench.

the expected SXI count and processed images are shown in the modeling section (**Figure 8**). In order to avoid straylight from the Sun and the bright Earth penetrating to the focal plane

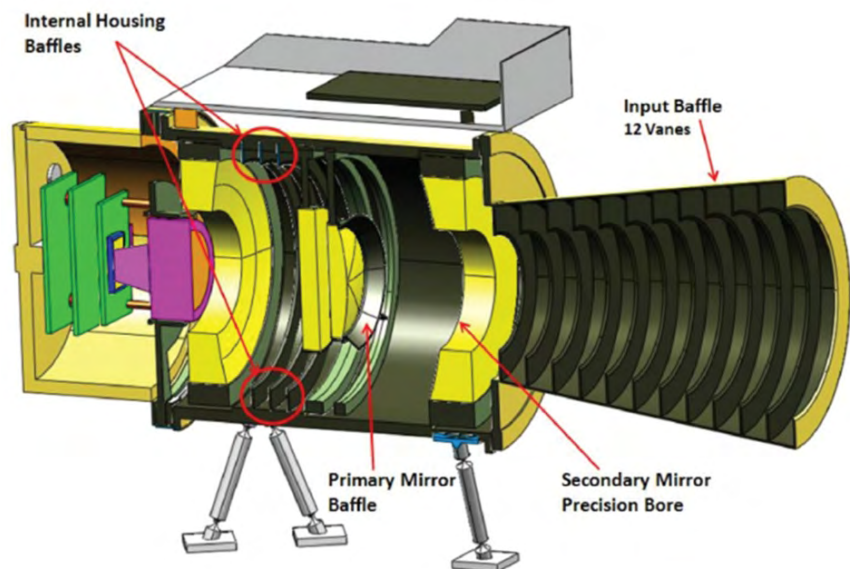

Fig. 11: Conceptual mechanical : on the left hand side is the image intensifier and on the front (right) is the baffle to control stray light levels.

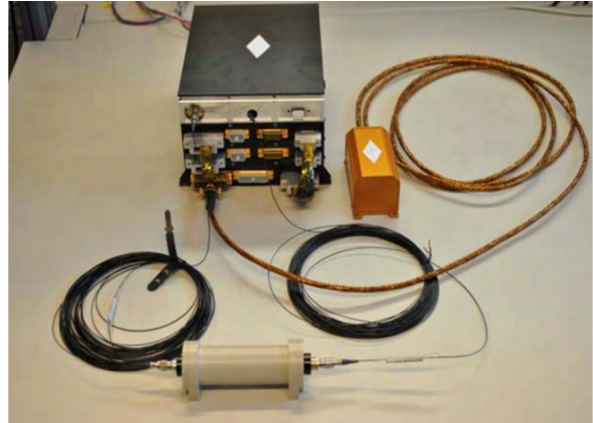
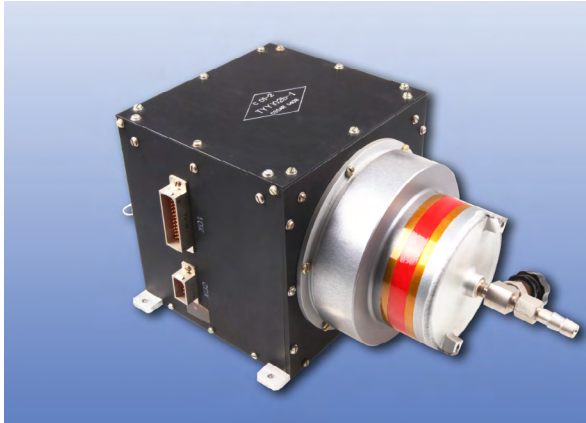

Fig. 12: Left panel – Example of the type of solar wind ion detector (flown on Chang'E-1/2) that will be adopted for SMILE LIA. **Right panel** – Example of fluxgate magnetometer (both from CAS/NSSC).

the SXI incorporates an optical/UV filter and a ~ 0.7 m long baffle (which is clearly visible in **Figure 10**, giving a view of the SXI from the top, and in **Figure 13**, left panel, showing the SMILE flying configuration).

The UVI is a four mirror reflective telescope covering the band-pass 160 – 180 nm, which is selected by appropriately coating the optical surfaces and the detector. The detector is an image intensifier comprising a photocathode, microchannel plates

for electron multiplication, a phosphor and a CMOS sensor. The UVI, shown in **Figure 11** is responsibility of the University of Calgary, Canada (PI: Eric Donovan).

The in situ package on board SMILE includes the LIA and MAG instruments. The LIA (**Figure 12** – Left panel) is a top-hat analyser for protons and α particles, measuring their density, velocity and temperature and working in the energy range 50 eV – 20 keV, with a

360° FOV in azimuth, reaching $\pm 45^\circ$ in elevation by use of deflector plates. MAG (**Figure 12** – Right panel) is a fluxgate type magnetometer measuring both strength and direction of the local magnetic field. Its two sensors will be mounted on a boom some 2.5 m long, which is seen in its deployed configuration in **Figure 13** (left panel). Both instruments making up the in situ package are developed by CAS/NSSC, China (LIA PI: Lei Dai, MAG PI: Lei Li).

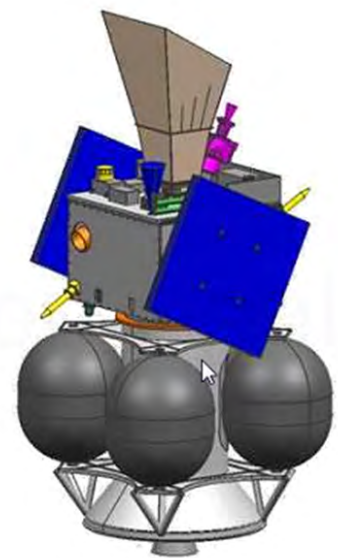
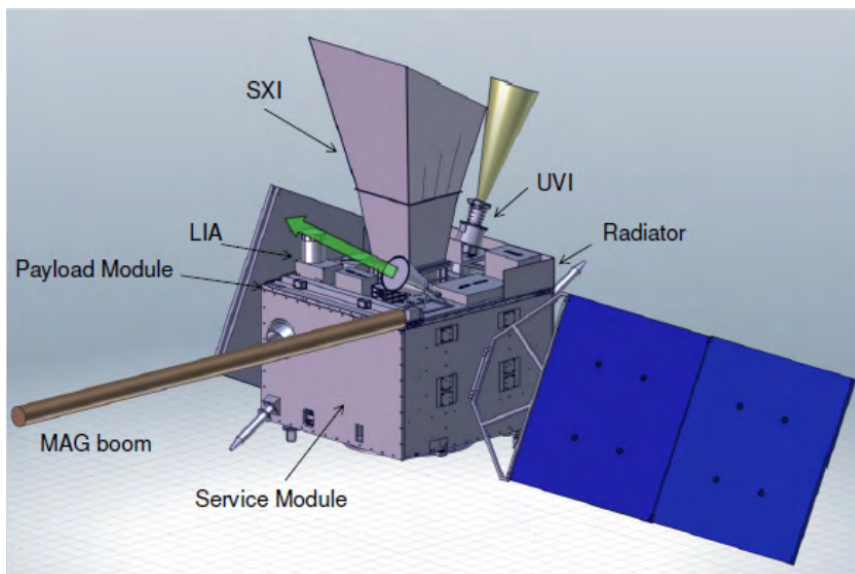

Fig. 13: Left panel – SMILE spacecraft flight configuration with its main elements labelled. **Right panel** – SMILE spacecraft including its propulsion module (from ESA-CAS Concurrent Design Facility)

SMILE Spacecraft and Orbit

A CAD drawing of the SMILE spacecraft is shown in **Figure 13** (left panel) with its main components labelled. Reflecting the truly collaborative nature of this mission, the provision of the SMILE elements is shared between CAS, ESA and national agencies. CAS provides the Propulsion Module, the Service Module, the spacecraft Prime Contractor, Mission Operations (with ESA contribution) and the Chinese instruments. ESA provides the Payload Module (the interface plate between the service module and the instruments and the sub-systems required to collect and download the scientific data – see **Figure 13**, left panel), the launcher and facilities for spacecraft integration and testing. The European/Canadian instruments will be provided by ESA member states and Canada. Science operations will be shared among the hardware institutes, ESA and CAS. An image of the SMILE spacecraft including the propulsion module, which will inject it into its operational highly elliptical polar orbit, is shown in **Figure 13** (right panel).

Two possible approaches to launch (scheduled for the end of 2021) are being considered: SMILE could be

passenger in a dual launch on a Soyuz rocket or could be launched on its own on Vega C. After spending some days or a few months (depending on the launch approach) in a low-Earth parking orbit, SMILE will be injected by its propulsion module into a highly elliptical, high inclination ($70^\circ - 90^\circ$) orbit currently baselined to have a period of ~ 50 hour and apogee altitude of ~ 19 Earth radii; this allows ~ 41 hour of SXI and UVI operations above an altitude of $\sim 50,000$ km, selected in order to avoid radiation damage to the SXI detectors during van Allen belt

passages near perigee (when the CCDs will be protected by closing a door mounted at the bottom of the baffle). LIA and MAG will be making measurements for most of the orbit.

During moderately strong solar wind flux ($N_{sw}=12 \text{ cm}^{-3}$ and $V_{sw}=400 \text{ km/s}$), the spacecraft will reach the solar wind near apogee (**Figure 14**) and a direct comparison between the solar wind strength impacting the Earth and the X-ray images of the cusps/magnetosheath and the auroral UV images will be made.

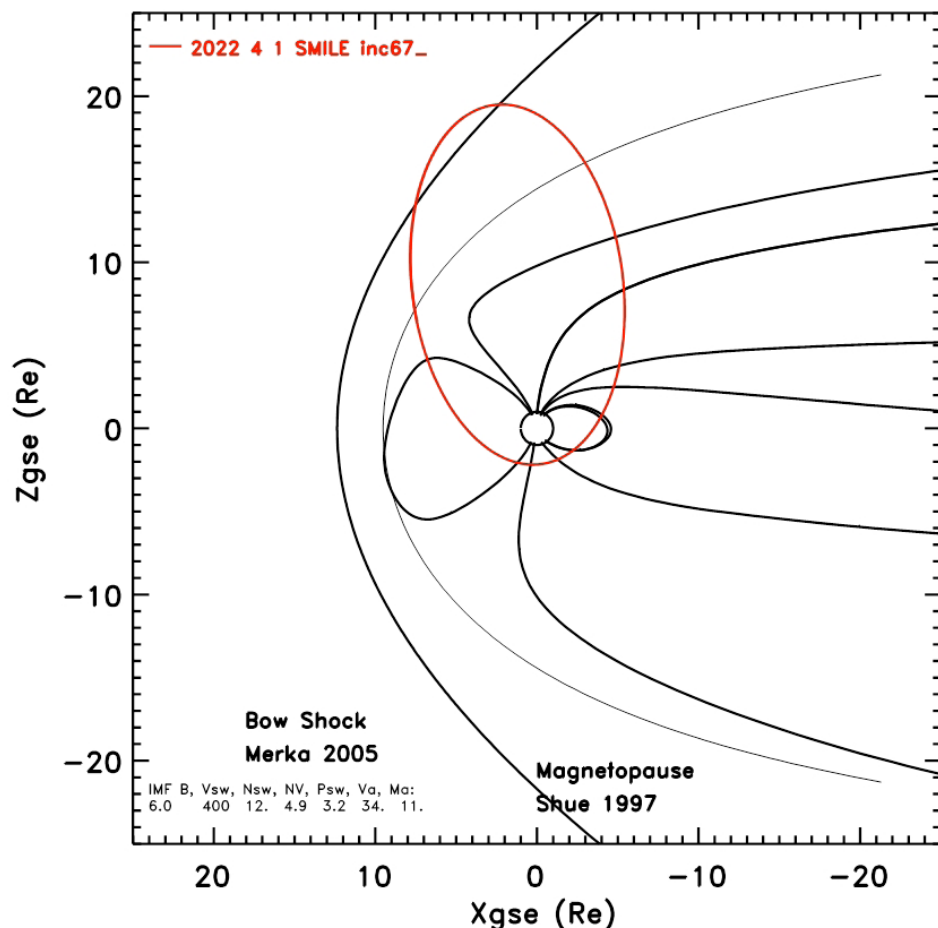
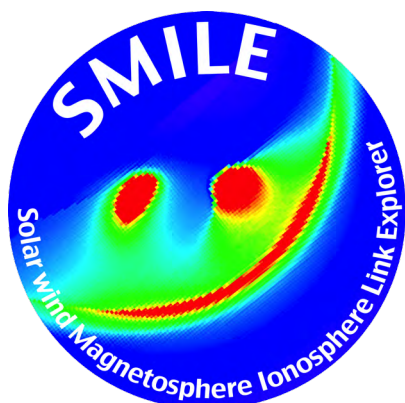

Fig. 14: SMILE orbit (red) on 1 April 2022 with an inclination of 67 deg. in X-Z_{GSE} coordinate system. The Earth magnetic field lines (black lines connected to the Earth), the magnetopause model from Shue et al., 1987 (grey) and the bow shock model from Merka et al., 2005 are shown for the solar wind parameters given in the left bottom corner ($B=6 \text{ nT}$, $V_{sw}=400 \text{ km/s}$, $N_{sw}=12 \text{ cm}^{-3}$).

SUMMARY AND RECOMMENDATIONS



In summary, SMILE will turn what is an unwanted variable background 'noise' for soft X-ray astronomical observations made along line of sights crossing the Earth's magnetosheath into a novel diagnostic tool of the conditions of geospace under the vagaries of the solar wind. SMILE will work in synergy with other space missions, current and forthcoming, probing the microscale (such as MMS, Cluster, Solar Orbiter, Solar Probe+, THOR ...), and with ground based observatories in the polar regions, to lead to a comprehensive understanding of solar-terrestrial interactions.

The cooperation of western nations with China from mission design to launch and flight operations is another first of the SMILE mission, and a facet that makes it a brilliant showcase, building on and extending the successful experience

of collaboration already proven with Double Star. Moreover, the imaging nature of two of the instruments in the SMILE payload offers excellent potential for outreach: the X-ray and UV images and videos that SMILE will return will captivate the public to science, to the physics of the Earth's magnetic field which involves many processes that are complex and essentially invisible to the naked eye. SMILE will make visible the magnetospheric bubble shielding our Earth from inclement solar wind conditions, and in doing so will make the science of solar-terrestrial interactions more understandable and fascinating.

SMILE will break completely new ground in the way we explore how the Earth environment responds to activity on the Sun and in the solar wind, and will open the way to future systematic and large scale monitoring based on state-of-the-art astronomical X-ray detection and mapping techniques applied to terrestrial space plasma science.

Simulations of the magnetosphere and its environment, through MHD modeling in China, Europe and USA are being used to optimize the instrument and mission design and the ISSI forum recommends continuing this effort during the project development, and

in particular comparing results obtained with different codes for the same solar wind conditions, in order to establish the margin of error inherent to model predictions. This is important in order to verify that the SMILE instruments can achieve the science requirements of the mission. In addition, other models such as Particle in Cell (PIC) simulations, could be used to obtain a complementary view of the magnetosphere, in particular the polar cusps. It is recommended to approach scientists developing such codes and request their support.

Archived data (e.g. velocity, temperature) collected by current in situ missions such as Cluster and THEMIS and more recently MMS, should also be used, in complement to MHD models, to further develop the instruments design and fix their orientation on the spacecraft (in particular LIA and SXI instruments).

Such ISSI forum meetings are ideal to exchange ideas and discuss recent developments on Sun-Earth connection science and monitor the SMILE mission implementation and it is recommended that such meetings be organized at regular intervals (once or twice a year).

太空 | TAIKONG

Participants

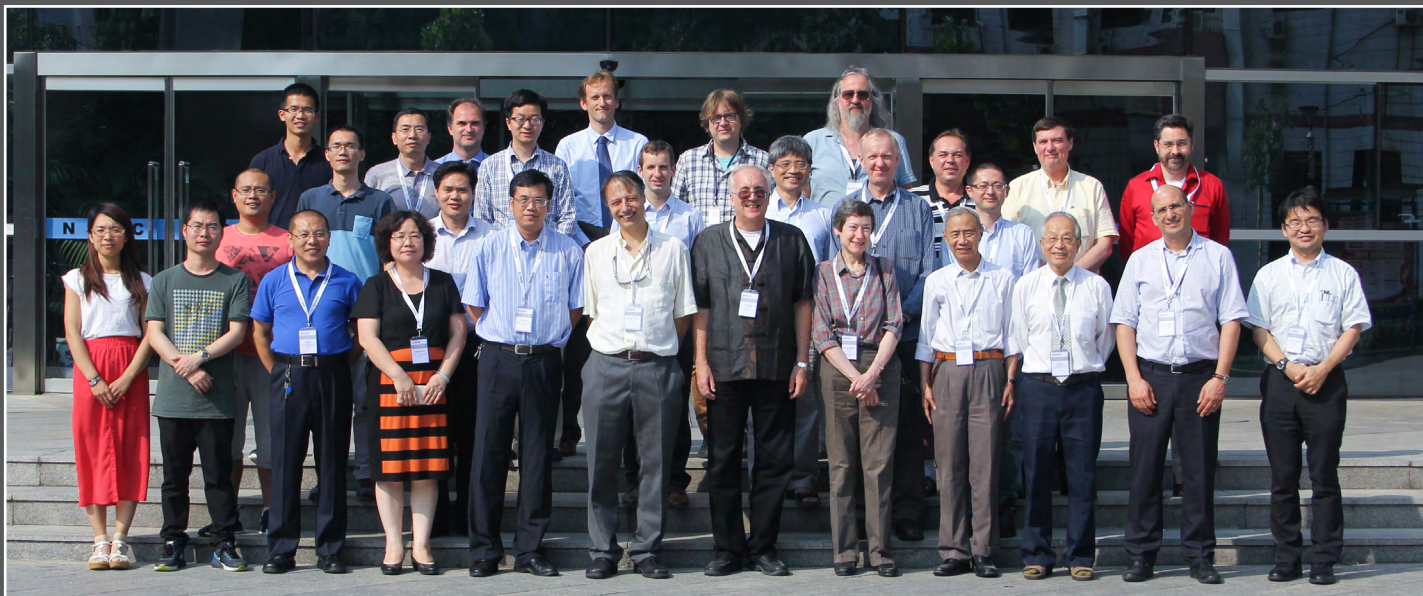

Zhiming Cai	Shanghai Engineering Center of Microsatellites, China
Lei Dai	National Space Science Center, CAS, China
Alexei Dmitriev	Institute of Space Science, National Central University, Chungli, Taiwan
Malcolm Dunlop	Space Science and Technology Department, RAL, UK
Philippe Escoubet	ESA/ESTEC, Netherlands
Yuichiro Ezo	Tokyo Metropolitan University, Japan
Maurizio Falanga	ISSI-BJ, China
Masaki Fujimoto	Japan Aerospace Exploration Agency, Japan
Hongqiao Hu	Polar Research Institute of China, China
Anders M. Jorgensen	New Mexico Tech University, USA
Kip Kuntz	The Johns Hopkins University, USA
Ziqian Liu	NSSC, CAS, China
Huawang Li	Shanghai Engineering Center of Microsatellites, China
Jing Li	National Space Science Center, CAS, China
Jann-Yenq Liu	National Central University, Taiwan
Tony Lui	Applied Physics Laboratory, The Johns Hopkins University, USA
Yoshizumi Miyoshi	Nagoya University, Japan
Zuyin Pu	Peking University, China
Walfried Raab	ESA/ESTEC, Netherlands
Graziella Branduardi-Raymont	Mullard Space Science Laboratory, University College London, UK
Andrew Read	University of Leicester, UK
Denis Rebuffat	ESA/ESTEC, Netherlands
Steve Sembay	University of Leicester, UK
David Sibeck	NASA / GSFC, USA
Tianran Sun	National Space Science Center, CAS, China
Brian Walsh	Boston University, USA
Chi Wang	National Space Science Center, CAS, China
Ji Wu	National Space Science Center, CAS, China
Xiaoxin Zhang	National Center for Space Weather China Meteorological Administration, China
Jianhua Zheng	National Space Science Center, CAS, China
Xiaocheng Zhu	Shanghai Engineering Center of Microsatellites, China
Qiugang Zong	Peking University, China